

**25L Dark stainless steel 7 function combination microwave oven with touch to open door and 10 auto cook programs.**



## Product Details

### FEATURES

---

Fan forced and grilling with microwave function

Quick start reheat

10 auto cook programs

Touch to open door

---

Save your favourite program

5 power levels

Childproof lock

---

### BENEFITS

---

#### BAKE. ROAST. RE-HEAT.

This appliance puts the 'oven' in 'microwave oven' by taking your microwaving ability to the next level. By using the convection heating function, you can now roast a whole chicken with perfectly crispy skin or bake muffins, bread, and cakes in your microwave.

#### SEAR. CHARGRILL. MELT.

The grill function will elevate your cooking experience far beyond warming and heating. Now you can brown and sear meat, chargrill vegetables, and melt cheese in one compact appliance.

---

#### HEAT FOOD FASTER

900W of high-powered heating gets your food piping-hot fast.

#### ACCOMMODATE LARGER DISHES

Whether entertaining for family or friends, the wide glass turntable gives you the option of cooking larger dishes when you need to.

---

#### SPACIOUS INSIDE, SLIM OUTSIDE

This appliance has a slimline exterior to take up less space, but with a large internal capacity you still have plenty of room for cooking all of your favourite crowd-pleasing dishes.

---

## Specifications

### PRODUCT PROFILE

---

Domestic warranty details (yrs) 2

---

Type of Microwave combination microwave

---

### PROGRAMS

---

#### PROGRAM OPTIONS

---

Number of Programmed functions 10

---

Auto cook programs Yes

---

Auto weight defrosting programs Yes

---

Auto weight programs Yes

---

### INTERNAL

---

Internal depth (mm) 346

---

Turntable diameter (mm) 315

---

### COOKING MODES

---

Number of combination cooking modes 4

---

### DIMENSIONS

---

#### PRODUCT

---

Total height (mm) 388

---

Total width (mm) 595

---

Total depth (mm) 470

---

### CONTROLS

---

Controls touch

---

Display LED

---

Child safety Yes

---

## TIMER

---

Type of timer	fully programmable timer
Signals	end
Timer functions	acoustic signal,duration,minute minder,time of day,end

---

## INTERIOR

---

Interior finish	stainless steel
Grill	radiant
Capacity (litres)	25

---

## POWER

---

Power Connection	10 amp plug and cord
Microwave power watts	900
Grill power watts	1100

---

## CONTROLS

---

Number of power levels	5
------------------------	---

---

## EXTERIOR

---

Type	built in
Fascia material/Colour	glass
Trim	No
Trim material	Dark stainless steel

---

## DOOR

---

Door material (exterior)	Dark stainless steel/glass
Door opening mechanism	Touch to open
Door opening	side opening

---

## SHIPPING

---

Shipping Volume (m3)	0.19
Shipping Weight (Kg)	24.0

---

**POWER**

---

Convection power watts	2400
------------------------	------

---

**SHIPPING**

---

Pack Dimensions Height (mm)	533
-----------------------------	-----

---

Pack Dimension Width (mm)	655
---------------------------	-----

---

Pack Dimension Depth (mm)	536
---------------------------	-----

---

# Dimensions

**Model:**  
EMB2529DSE

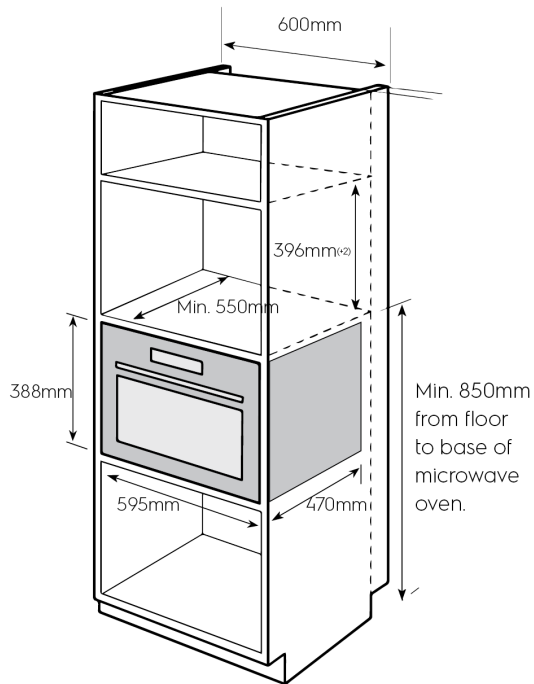

## Side view

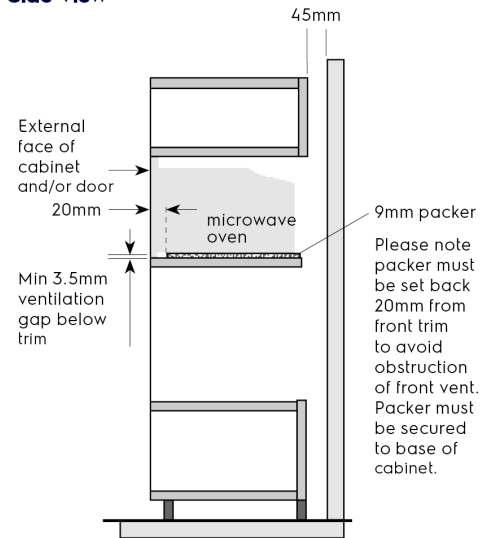

## Flush fit top view

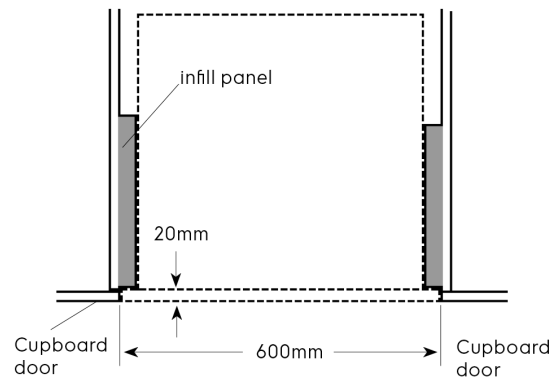

## Terms and Conditions

### IMPORTANT

This is a guide of product dimensions only. For complete installation instructions, refer to the manual provided with product.

### PRODUCT INFORMATION

The descriptors and illustrations in this publication apply to the specific products and models described as at the date of issue. Under our policy of continuous product development, product specifications may change without notice. Prospective purchasers should therefore check with their retailer to ensure this publication correctly describes the products that are being offered for sale. All information supplied is to be used for general reference purposes only and is on the understanding that Electrolux Home Products Pty Ltd (Australia) and Electrolux (NZ) Ltd (New Zealand) will not be liable for any loss, liability or damage of whatever kind arising as a result of reliance on such information. Colours of products illustrated are as close as printing limitations allow. Electrolux will at all times comply with its obligations pursuant to law including Trade Practices (Australian Consumer Law) Act and Regulations.

### WARRANTY

This warranty only applies to Appliances purchased and used in Australia or New Zealand and used in normal domestic applications and is in addition to (and does not exclude, restrict, or modify in any way) any non-excludable statutory warranties in Australia or New Zealand. All warranties are subject to the conditions set out in the warranty card accompanying the product when purchased.

#### ELECTROLUX HOME PRODUCTS AUSTRALIA

telephone: 1300 363 640

fax: 1800 350 067

email: [customercare@electrolux.com.au](mailto:customercare@electrolux.com.au)

web: [www.electrolux.com.au](http://www.electrolux.com.au)

#### ELECTROLUX HOME PRODUCTS NEW ZEALAND

telephone: 09 573 2230

fax: 09 573 2221

email: [customercare@electrolux.co.nz](mailto:customercare@electrolux.co.nz)

web: [www.electrolux.co.nz](http://www.electrolux.co.nz)